

CONSEW[®]

OPERATING INSTRUCTIONS
FOR

**744R20, 744R30,
745R20, 745R30.**

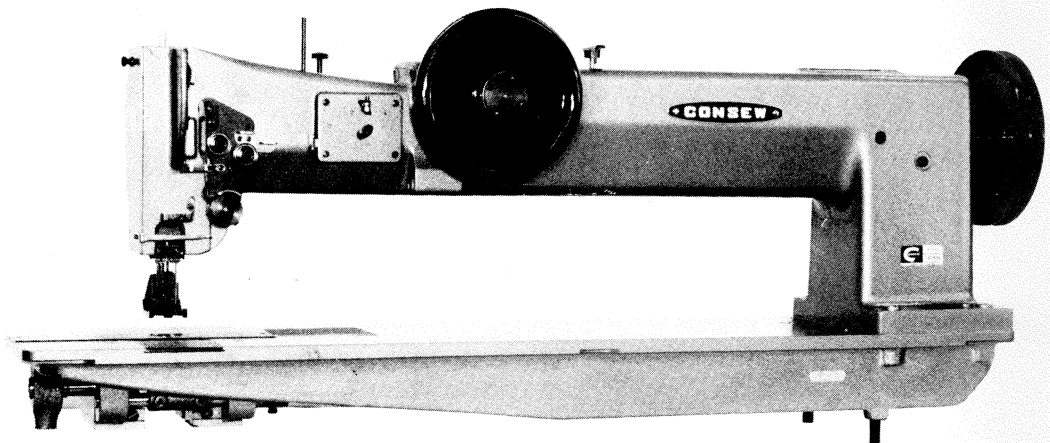

CONSOLIDATED SEWING MACHINE CORP.

OPERATING INSTRUCTIONS CONSEW 744R/745R SERIES MODEL

This is a guide to use of CONSEW 744R/745R series model long-arm high speed for heavyduty materials sewing machine with compound feed and walking foot feeding mechanism, under the best condition.

Please read this guide thoroughly so that you may expect good performance.

Specifications

	SINGLE NEEDLE	
	744R20	744R30
MAX. SPEED (s.p.m.)	1,500	
MAX. STITCH (mm)	10	
MAX. LIFT OF FOOT (mm)	20	
NEEDLE	DY x 3 (standard No. 24) · SY5213 · 794	
BOBBIN SIZE (mm)	37 ϕ x 13	
WORKING SPACE (mm)	508 x 153	762 x 153
BED DIMENSION (mm)	846 x 230	1,100 x 230
POWER REQUIRED (W)	400W, 2P	
MOTOR PULLEY DIA.(mm)	70 ϕ / 60 ϕ (50/60Hz)	
NET/GROSS WEIGHTS M ³	109/kgs.	151/kgs. 0.377/M ³

	TWIN NEEDLE	
	745R20	745R30
MAX. SPEED (s.p.m.)	1,500	
MAX. STITCH (mm)	10	
MAX. LIFT OF FOOT (mm)	20	
NEEDLE	DY x 3 (standard No. 24) · SY5213 · 794	
BOBBIN SIZE (mm)	37 ϕ x 13	
WORKING SPACE (mm)	508 x 153	762 x 153
BED DIMENSION (mm)	846 x 230	1,100 x 230
POWER REQUIRED (W)	400W, 2P	
MOTOR PULLEY DIA.(mm)	60 ϕ / 50 ϕ (50/60Hz)	
NET/GROSS WEIGHTS M ³	112/kgs.	154/kgs. 0.377/M ³
NEEDLE SPACING	3/16" (4.7 mm), 2-3/8" (60 mm), Standard 1/4" (6.4 mm)	

USE FOR

Tent, Sail Cloth, Rubberized Fabrics, Heavy Synthetic, Heavy Upholstery Materials, Fiber Plate, Leather, etc.

— INDEX —

CONTENTS

	Page
Setting up the machine	2
Caution before starting the operation	2
Oiling	2 — 3
Needle	3
Thread	4
Winding the lower thread on the bobbin	4
Removing and inserting the bobbin	4
Threading the needle	5
Regulating the thread tensions	5
Adjustment of the stitch	6
Adjustment of the pressure	6
Reverse stitching	6

INSTRUCTIONS FOR ADJUSTMENT

Relative position of vibrating and lifting presser bar, also, of the needle and the needle hole of the feeder	7
Adjustment of the height of the feed dog	7
Timing between the hook and the needle	8
Adjustment of bobbin case opener	9
Adjustment of the height of the presser feet	9
Timing of the vibrating and lifting presser feet	10
Adjustment of the clearance for the vibrating and lifting presser feet	10
Adjustment of the thread controller spring	11
Replacement of the connection belt	11 — 12
To re-engage the safety clutch	13
Adjustment of the built-in bobbin winder	14
Adjustment of the oiling for the hook saddle	14
Treadle assembly complete set	15

2

SETTING UP THE MACHINE (Fig. 1)

Setting up the machine on the table after removed two pieces of supporting bolts (A) under the bed.

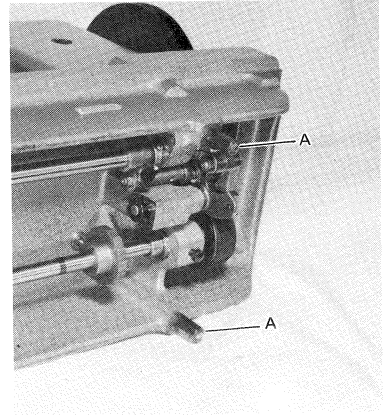

Fig. 1

CAUTION BEFORE STARTING THE OPERATION

1. Do not operate the machine, even if only for testing and or idling, unless it has been properly oiled at every spot and reservoir required lubrication. During practice period the new machine should be oiled more frequency.
2. The machine pulley turns toward to the operator.
(The auxiliary hand wheel turns to clockwise.)
3. Do not operate the machine at maximum speed of 1,500 s.p.m., for starting operation. To take practice operation at speed of 1,000 s.p.m., but operating speed are to be changed to proper condition suitable for the materials in case by case.

OILING (Figs. 2, 3, 4 & 5)

1. Oil should be applied at each of the place designated by arrows in Fig. 2, 3, 4 & 5.

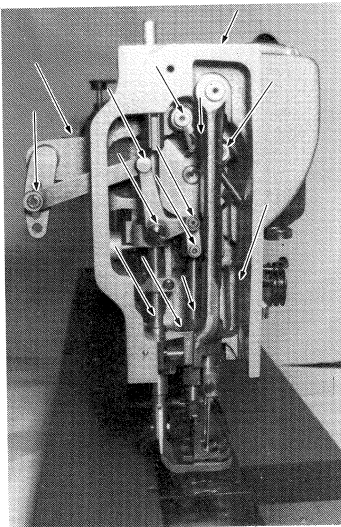

Fig. 2

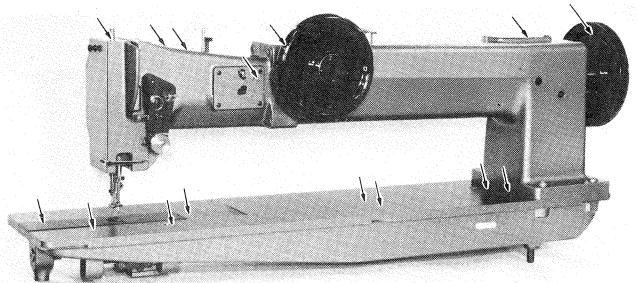

Fig. 3

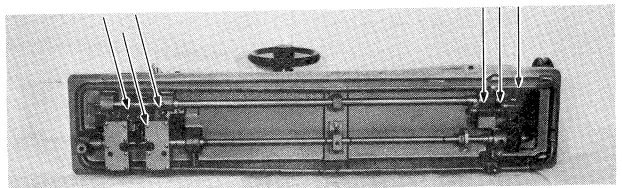

Fig. 4

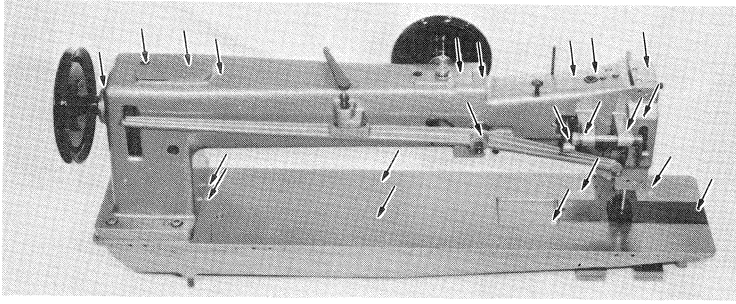

Fig. 5

2. To fill the oil for reservoir of hook saddle from the hole after taken out the oil gauge (Fig. 6 A) and pour the oil until the oil level reached to the upper reference line of the oil gauge (Fig. 6-1 B).
3. When in continuous use, it should be oiled at least twice a day.

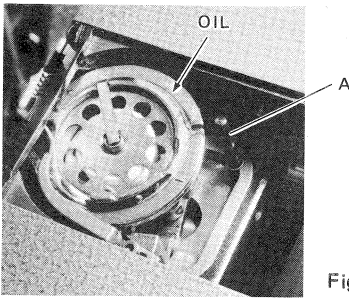

Fig. 6

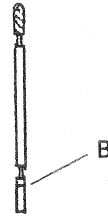

Fig. 6-1

NEEDLE (Figs. 7 & 8)

1. CONSEW 744R/745R series machines are set up to use standard needle of DY x 3 (standard No. 24) - SY5213 - 794.

The size of needle to be used should be determined by the size of thread, type and thickness of the sewing materials.

2. To insert the needle, turn the machine pulley over toward you until the needle bar moves up to its highest point, put the needle up into the needle bar as deeply as it will go, with the long groove of the needle faced outside (745R).

Tighten the needle set screw securely.

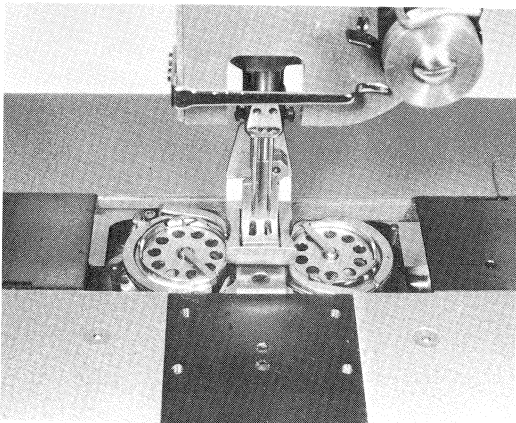

Fig. 7

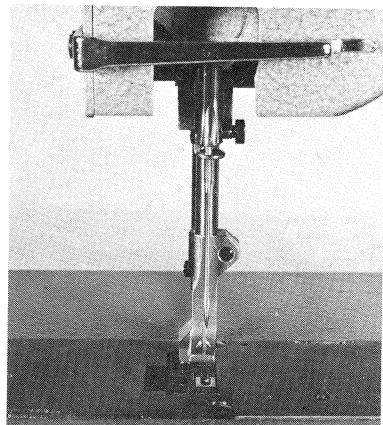

Fig. 8

4

THREAD (Fig. 9)

Normally, left twisted thread is used for upper (needle) thread. (But, for left side needle of twin-needle 745R machine, it can be finished in fine results with right twisted thread.)

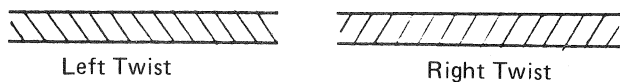

Fig. 9

WINDING THE LOWER THREAD ON THE BOBBIN (Figs. 10 & 11)

1. Pass the thread through (1) - (4), and wind several times around the bobbin which set up to the shaft of bobbin winder. (5)
2. Press the lever (6) to arrow direction, then the bobbin winds the thread automatically, in engage with the operation of the machine.
The bobbin will automatically be stopped after the bobbin is filled with thread.

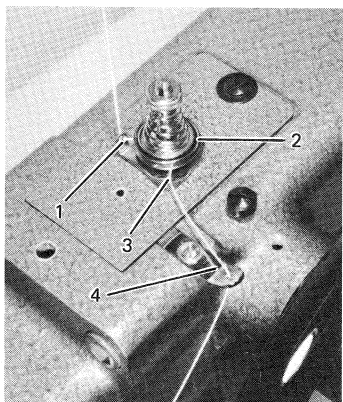

Fig. 10

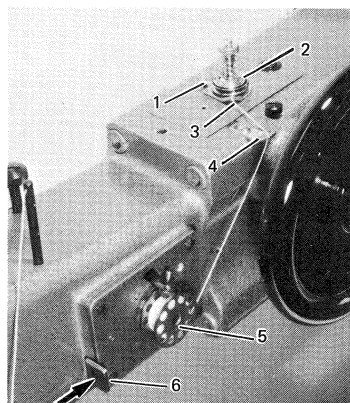

Fig. 11

REMOVING AND INSERTING THE BOBBIN (Figs. 12 & 13)

1. Draw back the side plate (1) on the bed of the machine, and raise the hinged latch (2) to a vertical position, then remove and insert the bobbin.
2. Insert the bobbin and pull thread out about 4–5cm(3), then push down the hinged latch (2) and draw the thread end under the tension spring (4).
3. When closing the side plate (1), leave just enough space for the thread to pass through.

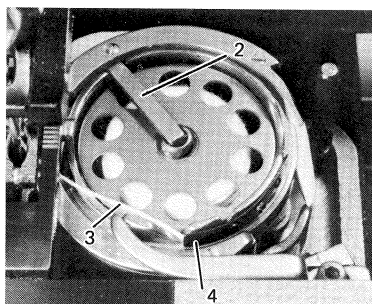

Fig. 12

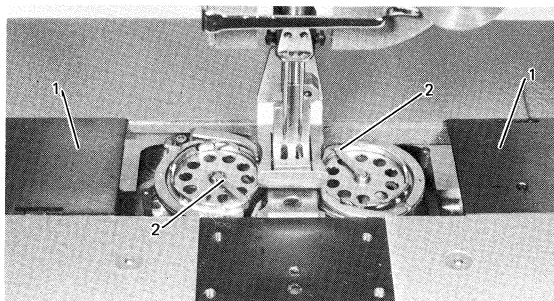

Fig. 13

THREADING THE NEEDLE

1. Pass the thread from thread guide (1) - eyelet (2) - tension disc (3) - tension thread guide (4) - guide (5) - thread take-up spring (6) - guide (7) - take-up lever (8) - guide (7) - lower guide (9) - self threading needle bar thread guide (10) - through the eye of the needle (11).

(Remark) Wind the thread a single time to tension thread guide (4).

2. With the left hand hold the end of the needle thread leaving it slack from the hand to the needle. Turn the machine pulley over toward you until the needle moves down and up again to its highest point, thus catching the bobbin thread, draw up the needle thread, and the bobbin thread will come up with it through the hole in the feed dog. Lay the threads back under the presser feet and close the slide.

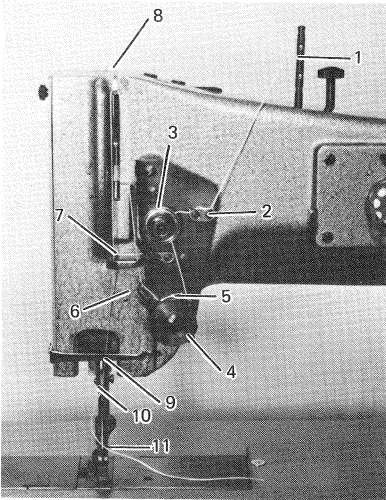

Fig. 14

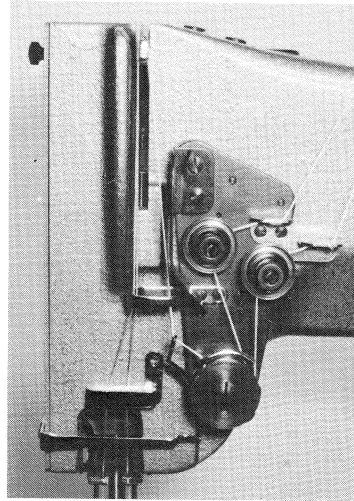

Fig. 15

REGULATING THE THREAD TENSIONS (Figs. 16 & 17)

1. The tension on the needle thread is regulated by the thumb nut (Fig. 16 A).
2. The tension on the bobbin thread is regulated by the screw of the tension spring on the outside of the bobbin case (Fig. 17 A).

To increase the tension, turn over nut or screw to the right, and to decrease the tension, turn over nut or screw to the left.

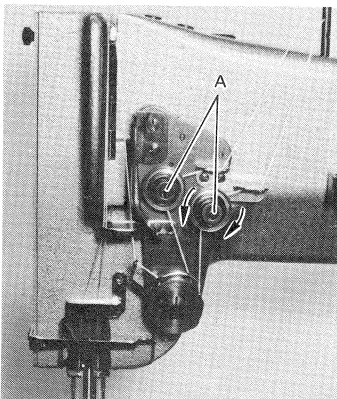

Fig. 16

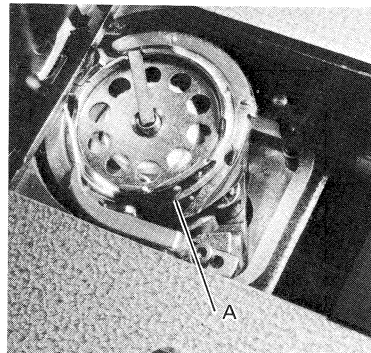

Fig. 17

6

ADJUSTMENT OF THE STITCH LENGTH (Fig. 18)

The length of stitch is regulated by pressing down the button (1) with left hand, while turning the machine pulley (2) slowly with right hand in the condition of setting the top of button (1) to the feed eccentric.

To increase the length of stitch, turn the machine pulley over toward you. To decrease the length of stitch, turn the machine pulley to opposite direction.

When the desired length of stitch is obtained, operate the machine after fully confirmed releasing the button (1) to the original position.

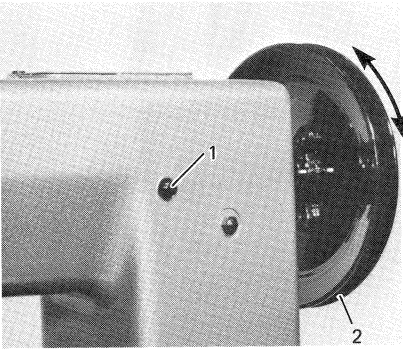

Fig. 18

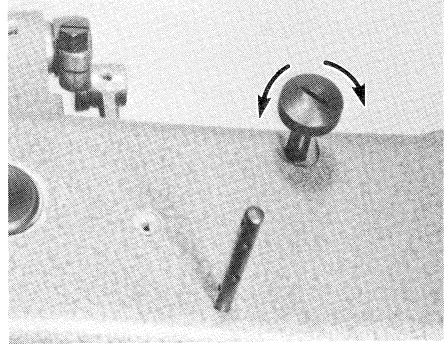

Fig. 19

ADJUSTMENT OF THE PRESSURE (Fig. 19)

The pressure of the presser feet is regulated by the adjusting screw.

To increase the pressure, turn the screw to clockwise, and decrease it, turn the screw to counter-clockwise.

REVERSE STITCHING (Fig. 20)

The chain for the feed reversing pedal is connected to the hook of feed reversing lever (A) underneath of the bed of the machine.

To feed the work toward you, press down firmly on the feed reversing pedal, and do not stop to press down on the way.

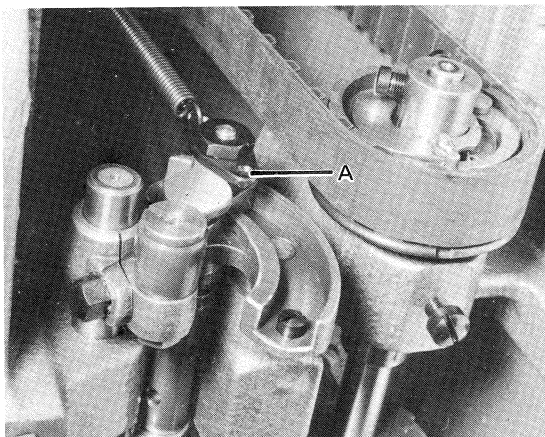

Fig. 20

INSTRUCTIONS FOR ADJUSTMENT

RELATIVE POSITION OF VIBRATING AND LIFTING PRESSER BAR, ALSO, OF THE NEEDLE AND THE NEEDLE HOLE OF THE FEEDER (Figs. 21 & 22)

1. The distance between the vibrating presser bar (1) and lifting presser bar (2), after adjusting the feed eccentric so that there is no feed movement of the needle bar, should be 15.5 mm (one needle) and 14.5 mm (two needle). To adjust by the screws for connecting crank (3).
2. Normally, relative position of the feed dog against the needle, the needle should be passed through the center of the needle hole of the feed dog. To adjust by the screw for the feed rock shaft bell crank (4).
3. Securely tighten the screws after finished adjustment.

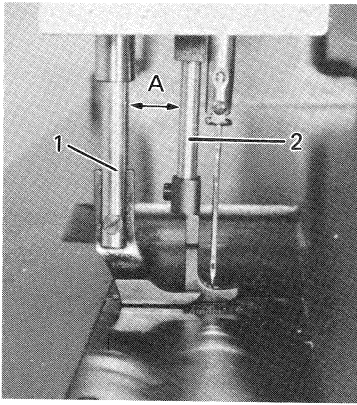

Fig. 21

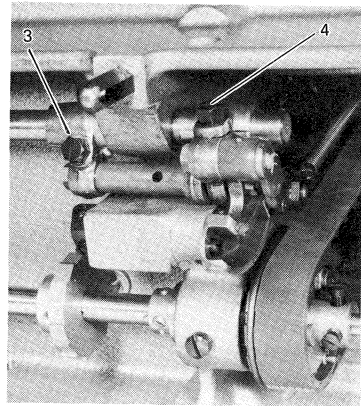

Fig. 22

ADJUSTMENT THE HEIGHT OF THE FEED DOG (Figs. 23, 24 & 25)

The maximum height of the feed dog from the surface of the needle plate is normally 1.3 mm.

To adjust this height by the screw on the feed lifting cam fork of the feed bar and raise or lower the feed dog, as may be required, and retighten the screw (1).

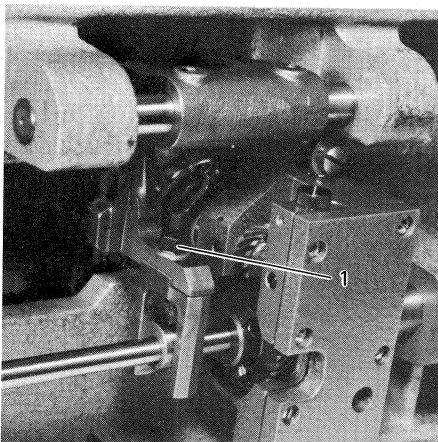

Fig. 23

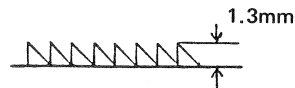

Fig. 24

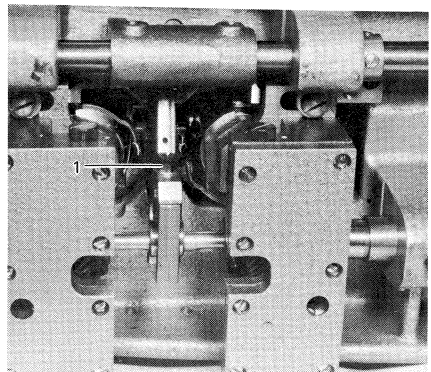

Fig. 25

TIMING BETWEEN THE HOOK AND THE NEEDLE (Fig. 26)

Set the feed eccentric with the button at no feeding position, and confirm the length between vibrating and lifting presser bar should be 15.5 mm.

1. If the needle bar and sewing hook are correctly timed, the point of the hook will be at the center of the needle when the needle raised $3.8 \text{ mm} \pm 0.5 \text{ mm}$ from the lowest point.

For the adjustment of timing, loosen 2 screws (1) for hook driving gear, and tap this gear to the right or left in clearance of 2 mm on the hook driving shaft until the point of the hook is at the center of the needle.

Tapping to the right gives an earlier hook timing, and to the left gives later hook timing.

Except the above case, to adjust in changing gear condition between hook driving gear (2) and hook shaft gear (3).

Securely tighten the 2 set screws for hook driving gear after finished adjustment.

2. Normal clearance between hook point and scarf of the needle is in 0.02 - 0.1 mm.

(1) Loosen two screws (4) and (5) for hook saddle.

(2) Move hook saddle to right or left, as may be required, until hook point is as close to needle as possible without striking it.

(3) Then securely tighten two screws.

(4) To check the needle with careful attention free from bent before adjustment.

3. Height of the needle bar (Fig. 27).

Normal clearance between top of the eye of the needle and hook point is 2.2 mm.

In case the needle bar is incorrectly set, loose the needle bar connecting stud pinch screw (A) and place the needle bar in correct position as required above, then retighten the screw (A).

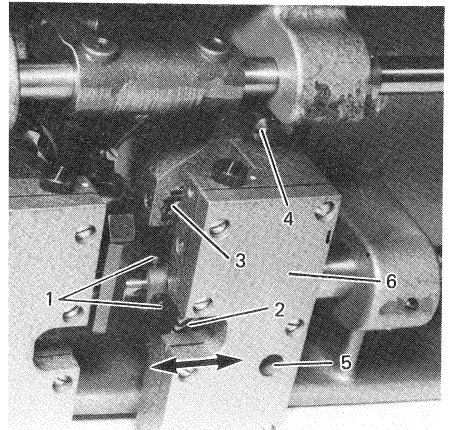

Fig. 26

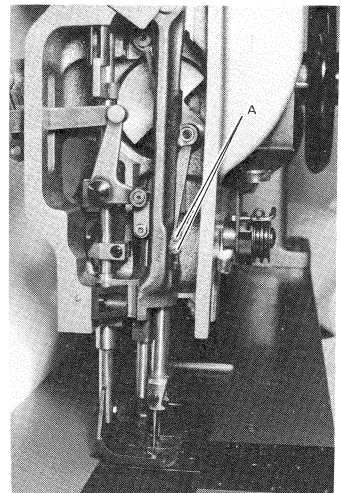
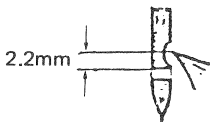

Fig. 27

ADJUSTMENT OF BOBBIN CASE OPENER (Fig. 28)

1. Turn the machine pulley or hand wheel (Fig. 31 D & E) until the top of the opener is located at the distance from the needle plate.
2. In this position, adjust it so that the clearance between the inside edge of the opener (A) and the top of the hook is about 0.3 - 0.8 mm.
3. Securely tighten the screw (B) after finished adjustment.

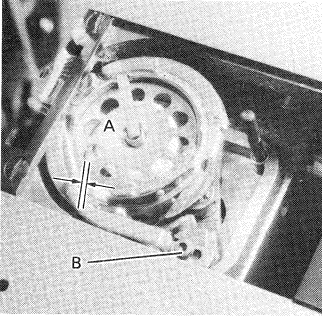

Fig. 28

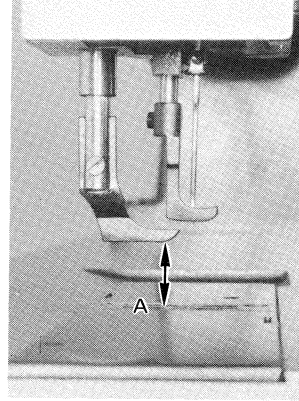

Fig. 29

ADJUSTMENT OF THE HEIGHT OF THE PRESSER FEET (Figs. 29, 30 & 31)

Normal distance between the surface of the needle plate (A) and vibrating presser foot at stopped position of the stop lever (C) is 19 mm.

When step on the lifting pedal, the stop lever (C) will be released by the lifting lever (B).

1. To change the relative lift of the presser feet, loosen the screw (1) at the above condition.
2. The height of lift of the presser feet is adjustable by moving the screw of presser bar lifting bracket.
3. Normal distance between presser bar position guide bracket (3) and presser bar position guide (4) is 7 mm.

Position of the vibrating presser foot to shift in left and right is to be adjusted by the screw (2) for presser bar lifting bracket and the screw (5) for presser bar position guide bracket.

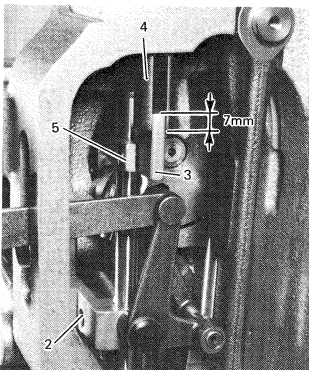

Fig. 30

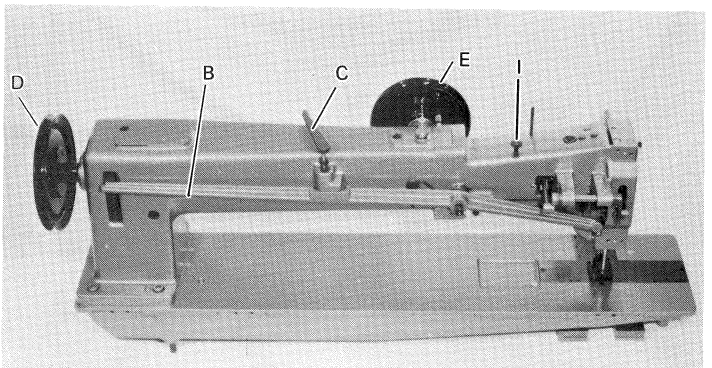

Fig. 31

TIMING OF THE VIBRATING AND LIFTING PRESSER FEET (Fig. 32)

The amount of lift of the vibrating and lifting presser feet should be regulated according to the thickness of materials being sewn.

The feet should lift just enough to clear the materials.

As a rule, the vibrating and lifting presser feet should lift an equal height, but some grades of work may require that they lift an unequal height.

To change the relative lift of the presser feet, loosen the screw (A) for lifting rock shaft crank and move the vibrating presser bar upward or downward as required, then securely tighten the screw (A).

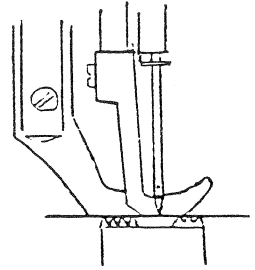

Upper Surface

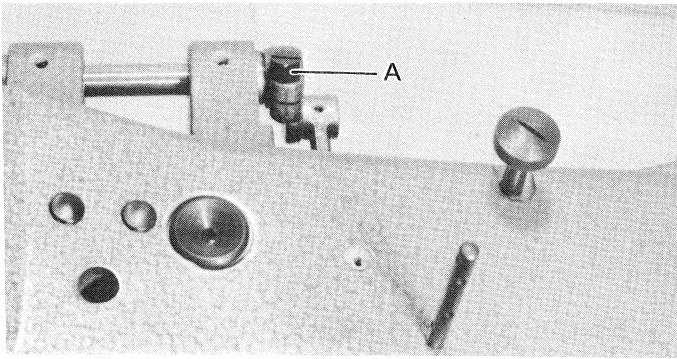

Fig. 32

ADJUSTMENT OF THE CLEARANCE FOR THE VIBRATING AND LIFTING PRESSER FEET (Fig. 33) (RE-ADJUSTMENT THE TIMING OF THE VIBRATING AND LIFTING PRESSER FEET - Fig. 32)

The amount of the lift of the alternating feed for the vibrating and lifting presser feet are to be adjusted by the lifting bell crank link screw stud (1).

To decrease the movement in setting the stud (1) at the upper position, and to increase the movement in setting the stud (1) at the lower position. After setting to the required position, securely tighten the stud (1) with nut (2).

The clearance for the vibrating and lifting presser feet are being adjusted at maximum, so that the clearance of them should be adjusted according to the materials being sewn.

The timing position for the vibrating and lifting presser feet should be regulated by Fig. 32.

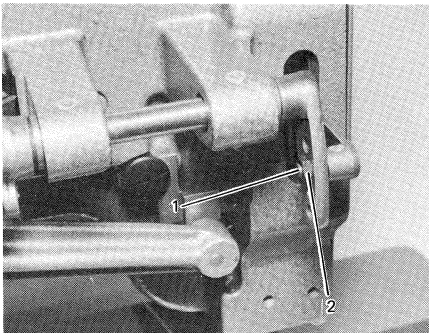

Fig. 33

ADJUSTMENT OF THE THREAD CONTROLLER SPRING (Fig. 34)

1. For more controller action on the thread, loosen the set screw (1) at the right of the controller and set the stop lever, and for less action set the stop higher.
2. To strengthen the action of the controller spring on the thread, loosen the spring stud screw (4) at the rear of the stop screw and turn the spring stud (5) slightly to the left with a screwdriver, or lighten its action turn to the right and securely retighten the spring stud screw.

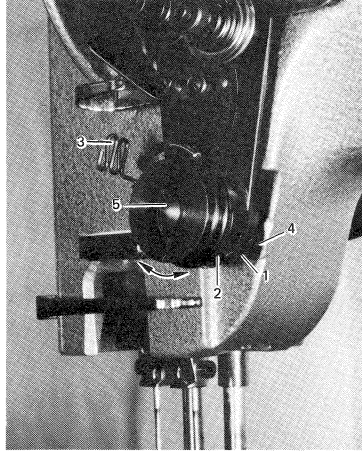

Fig. 34

REPLACEMENT OF THE CONNECTION BELT

A. When the connection belt removed from the pulley for adjusting and or replacing purposes of the parts, it should be replaced by the processes, as followings: (Figs. 35 & 36)

1. Turn the machine pulley toward you so that placed the take-up lever (A) at the highest position.
2. Turn the hook shaft with the fingers until the arrow mark on the hook driving shaft bushing collar (2) and the red point mark on the hook driving shaft bushing (1) are directly in line. Then replace the belt over the the upper and lower pulley.

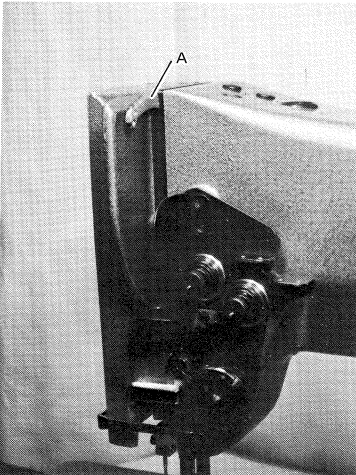

Fig. 35

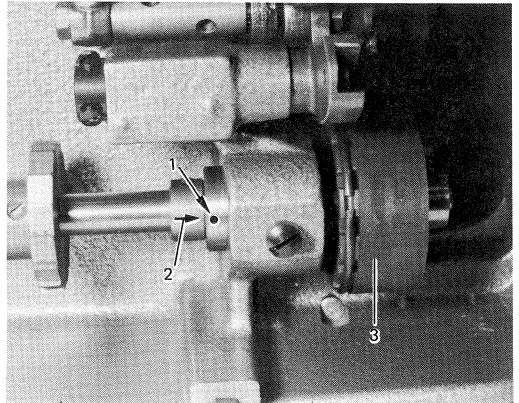

Fig. 36

12

B. Replacement of the connection belt when damaged. (Figs. 37 & 38)

1. Remove the upper arm plate and reservoir.
2. Slide the connection belt (A) off from lower and upper belt pulley.
3. Loosen the machine pulley adjustment screw (2) and two set-screws for the machine pulley (3), then remove the machine pulley.
4. Loosen the three screws in the arm shaft bushing (5) and remove the bushing (6).
5. Lift the belt up through the arm cap hole after removed the bushing (6) as far as possible and draw it out through the space normally occupied by the bushing.
6. Replace the connection belt as opposite processes as above for removing it.
7. Securely tighten all the screws, so as to fit the arm shaft, firmly, free from looseness.

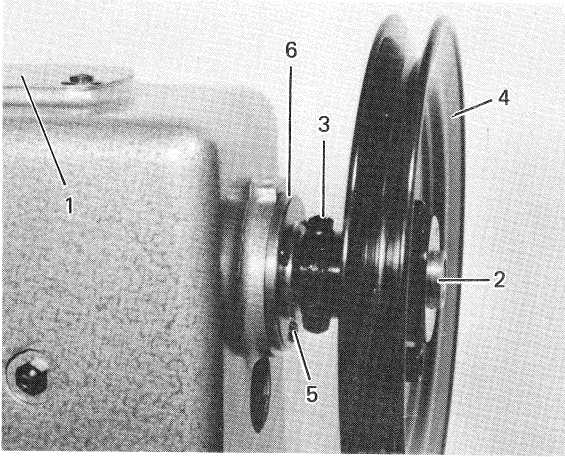

Fig. 37

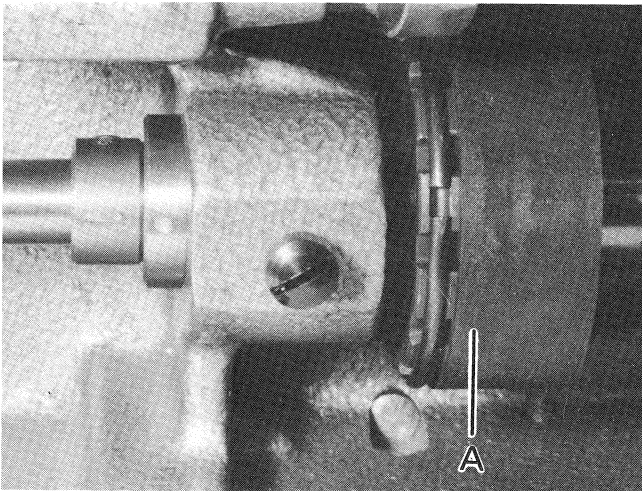

Fig. 38

TO RE-ENGAGE THE SAFETY CLUTCH (Figs. 39 & 40)

The hook driving shaft and the shaft of the sewing hook are splined to prevent the hook from getting out of time. The safety clutch located in the lower belt pulley prevents damage in the event of thread jamming in the sewing hook by releasing the locking lever in the pulley.

1. Take out jammed thread from the hook.
2. To re-engage the clutch, press down the lock stud (A), near the base of the arm by left hand and turn the machine pulley backward slowly by right hand, then the safety clutch will be released.
3. In the case easily releasing the safety clutch, adjust the pressure by the screw (B) for lower belt pulley after removed connection belt (C).
To increase the pressure in turning the screw (B) to clockwise and to decrease the pressure in turning the screw (B) to counter-clockwise.

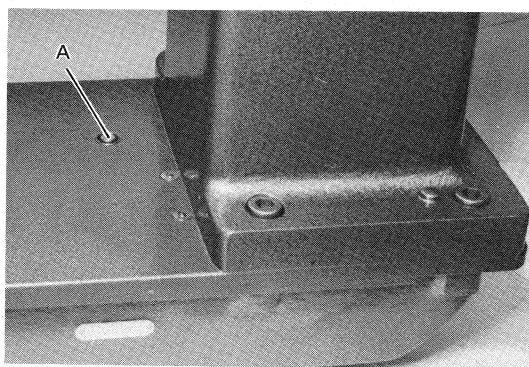

Fig. 39

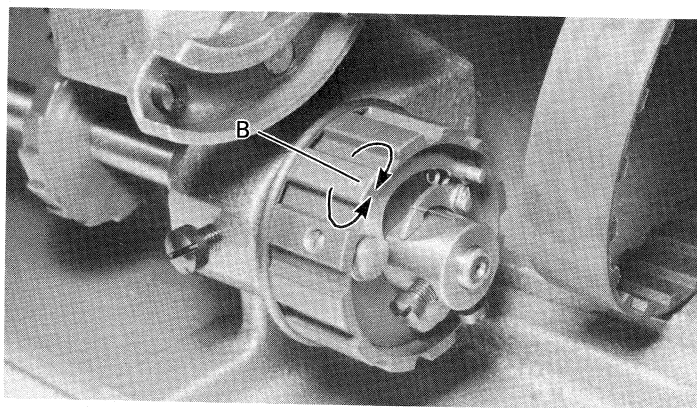

Fig. 40

ADJUSTMENT OF THE BUILT-IN BOBBIN WINDER (Figs. 41 & 42)

Adjust the volume of winding thread to the bobbin by the adjustment screw (1) for the winder in turning it to up and down.

Remove the plate (2) on the front of the arm and adjust the slippage of the shaft for the winder by the winder driving gear (3) in the arm shaft to shifting right or left.

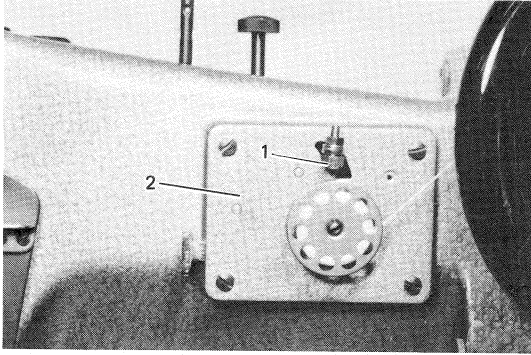

Fig. 41

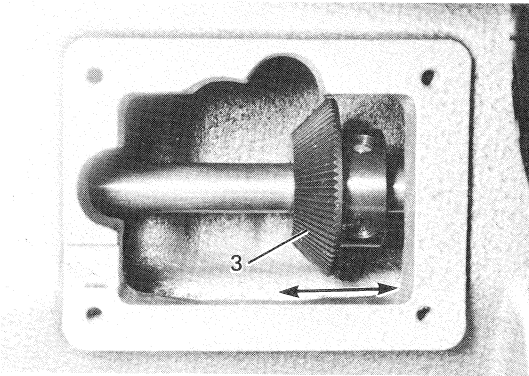

Fig. 42

ADJUSTMENT OF THE OILING FOR THE HOOK SADDLE (Fig. 43)

Loosen the screw for the oil adjustment dial (3) and adjust oil supply by turning the oil adjustment dial (2). Maximum oil supply at the directly in line of the point mark (1) on the hook saddle and the center line of the dial (2). Stop the oil supply at the vertical position of the center line of the dial (2).

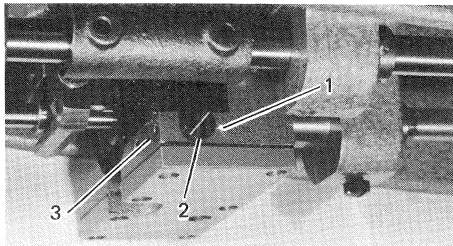
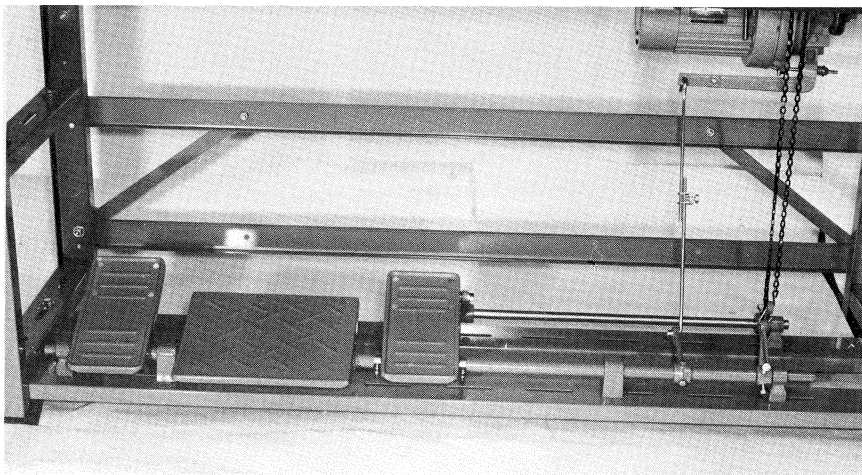
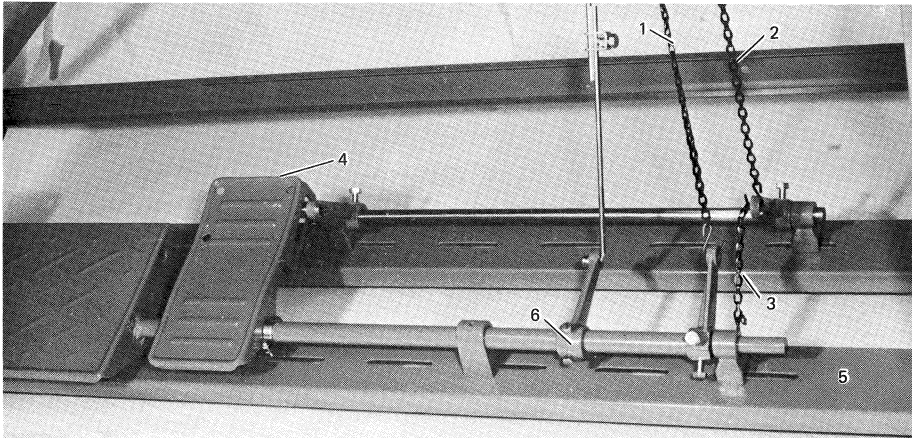

Fig. 43

TREADLE ASSEMBLY COMPLETE SET

- a. Construct treadle assembly complete set as shown.
- b. Chain 1, 2, 3 are strained tightly.
- c. Chain 3 is hooked crank one side, and the other hook of chain 3 is clinged the hole drilled stand horizontal plate.
- Chain 3 is used as stopper to prevent treadle 4 is not hit by camfollower.
- d. Screw 6 is driven tightly after crank set up correctly.



Completion of Treadle Set

Consolidated Sewing Machine Corp.

MAIN OFFICE

131 West 25th Street
New York, NY 10001
Tel: (212) 741-7788
Fax: (212) 741-7787

BRANCH OFFICE

7855 NW 29th Street, Bay 166
Miami, FL 33122
Tel: (305) 471-0200
Fax: (305) 471-0243