



THREAD CUTTING DEVICES

FLAT BED

2115FCA-V-C-TCB

With Treadle Switch and Thread Collection Container and air motor cutter.

2115FCA-V-C-TCB-SV

With 24 volt DC Solenoid Valve and Thread Collection Container and air motor cutter.

FLAT BED

3115FCA-V-C-TCB

With Reciprocating Thread Cutting Blade for heavy Threads, Treadle Switch and Thread Collection Container

3115FCA-V-C-TCB-SV

With Reciprocating Thread Cutting Blade for heavy Threads, 24 volt DC Solenoid Valve and Thread Collection Container

FEED-OFF-THE-ARM

2115FOTA-V-C-TCB

For Feed-Off-the-Arm machines with Treadle Switch, Thread Collection Container and air motor cutter.

2115FOTA-V-C-TCB-SV

For Feed-Off-the-Arm machines with 24 volt DC Solenoid Valve, Thread Collection Container and air motor cutter.

FEED-OFF-THE-ARM

6115FOTA-V-C-TCB

For Feed-Off-the-Arm machines with Treadle Switch, Thread Collection Container and air motor cutter.

6115FOTA-V-C-TCB-SV

For Feed-Off-the-Arm machines with 24 volt DC Solenoid Valve, Thread Collection Container and air motor cutter.

SIDE CUTTER

SCA-C-FL-TVP SERIES

Side Action Thread Chain Cutter for Overlock Machines

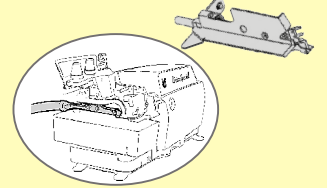

FLAT CUTTER

FCA-C-FL-TVP SERIES

Flat Action Thread Chain Cutter for Overlock Machines

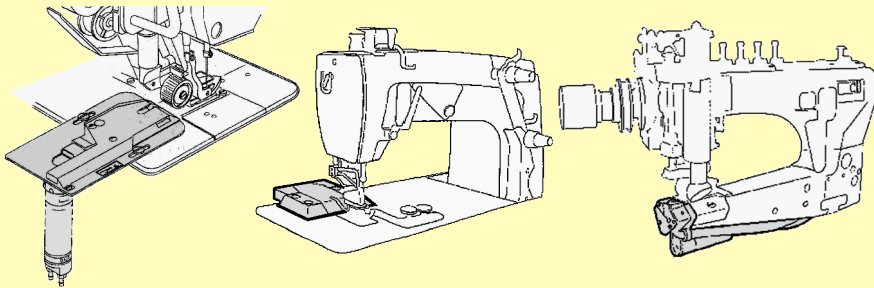
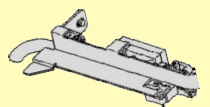

NOTE : this model has the same functions as the 2115FOTA-V-C-TCB and SV. The difference is that this design is for smaller diameter goods, such as child sized arms and sleeves

TAPE CUTTING DEVICES

WAISTBAND CUTTER

205NSA

AIR OPERATED HEAVY DUTY TAPE CUTTERS

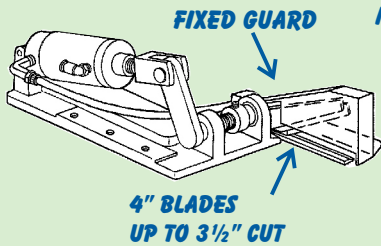

WAISTBAND CUTTER

605NSA

AIR OPERATED FAST ACTION TAPE CUTTERS WITH AIR OPERATED SAFETY GUARD

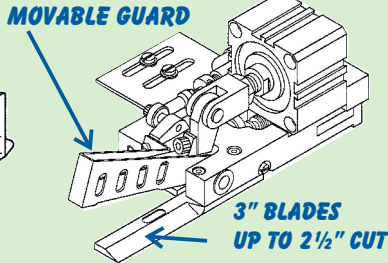

TAPE CUTTER

405NSA

(FIXED GUARD)
TAPE CUTTER WITH 1.5 INCH BLADE

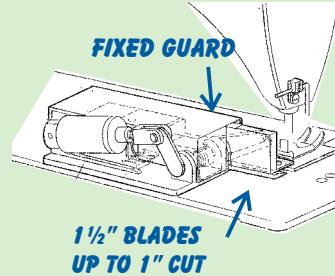

TAPE CUTTER

405NSA-SG

(MOVABLE GUARD)
TAPE CUTTER WITH 1.5 INCH BLADES

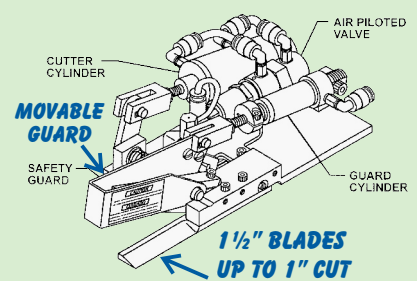

FOOT-LIFT AND REVERSE DEVICES

LOCKSTITCH 285A

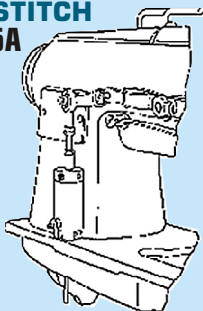

OVERLOCK 285B

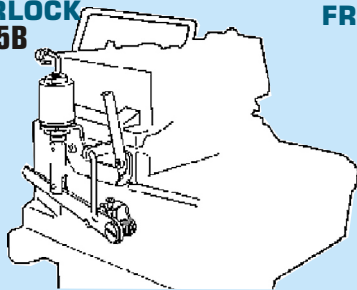

FRAME

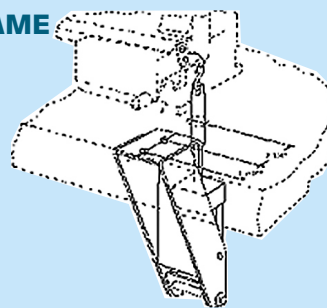

CHAINSTITCH

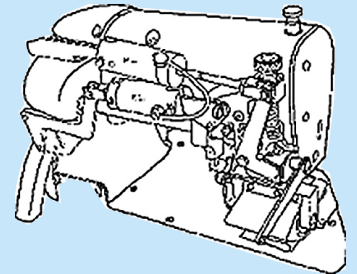

US BLINDSTITCH THREAD TRIM & FRAME OPENER

132FR

TRIM SYSTEMS FOR BLINDSTITCH MACHINES

- AIR OPERATED THREAD TRIM
- AIR OPERATED FRAME DROP

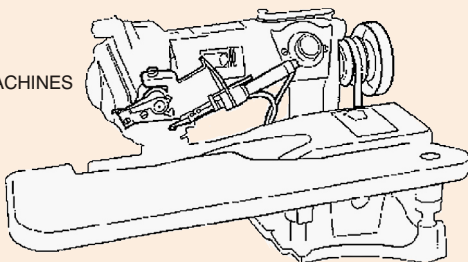

* Requires Servo Motor (not supplied)
(Example of a compatible Servo motor is the Ho Hsing I90M)

WASTE REMOVAL SYSTEMS

2505B

Dual chain and waste removal system with bag type container for Overlocks

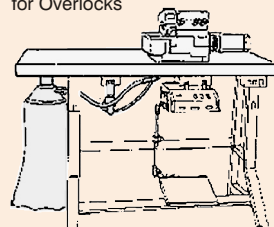

2507B

Dual chain and waste removal system with bag type container for Feed-Off-The-Arm machines

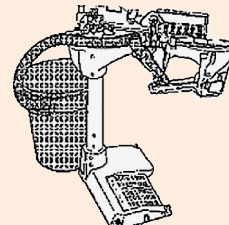

2505/Skiver

Dual chain and waste removal system with bag type container for Skiver machines

